

IMPORTANT: If you are experiencing slider issues, it may be due to a period of inactivity and an accumulation of debris in the mechanism.

Corrosion of vehicle components due to over exposure to very corrosive melting agents used on the roads can also be a second contributing factor.

Periodic maintenance as outlined below is a recommended first step. If this doesn't resolve the issue, perform the troubleshooting inspections to identify the source of the problem.

Periodic Maintenance:

Perform these steps every 3 months or more frequently as required. See LT-SK37U-03 for a complete list of maintenance requirements.

- 1) **Unlock, move and re-lock the slider.**
- 2) **Clean and remove debris from the mechanism as required.**
- 3) **Lubricate pivot points with penetrating oil, such as PB Blaster or Kroil as required.**

TROUBLESHOOTING

Inspection #1: Mounting Angle Elevation (Outboard Only)

If the mounting angles are not flush with the top of the tractor frame the vertical load of the trailer will bind the locking plungers. You must correct the mounting angle to ensure proper slider operation.

Step 1-1) Use a straight edge to check that the bed plate is flat.

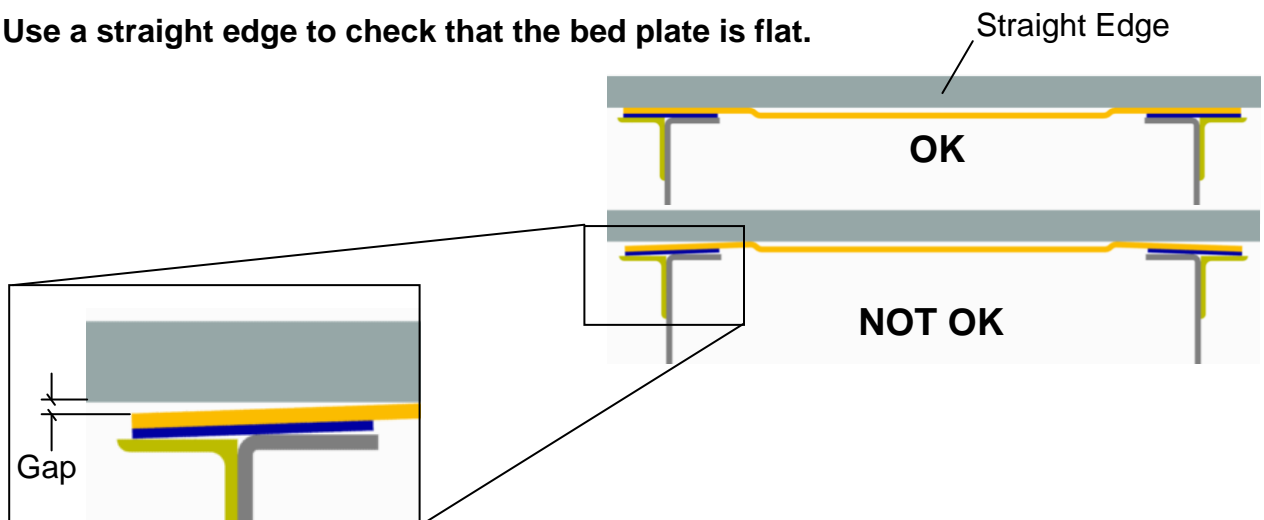

Inspection #1: Mounting Angle Elevation (Outboard Only) Con't

Step 1-2) Check for paint scraped off on either one or both of the inside edges of the slide plate.

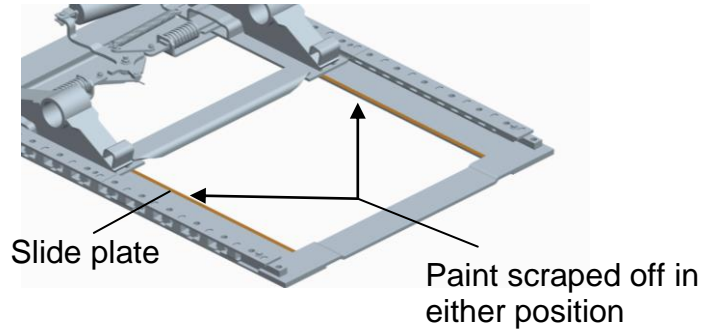

Step 1-3) Check that the slide mechanism is fully locked.

NOT OK

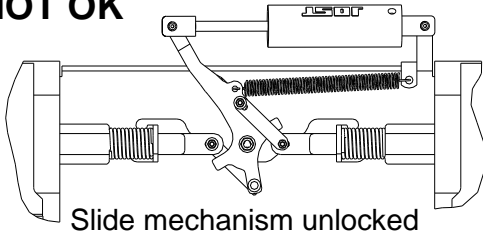

OK

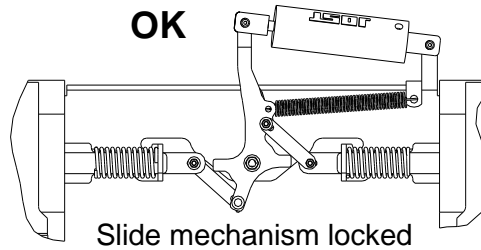

Step 1-4) Use a straight edge to check that the mounting angles are flush with the top of the tractor frame.

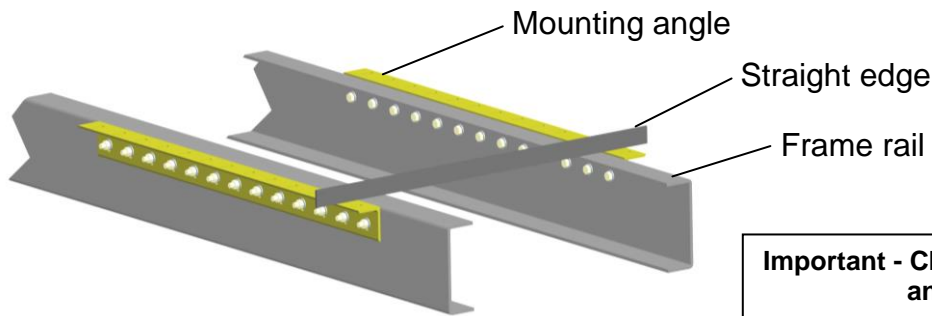

Note:
Do not remove the fifth wheel to perform this inspection.

Important - Check at both the front and the rear of the frame

Step 1-5) The maximum allowance above or below the tractor frame is .030 inches.

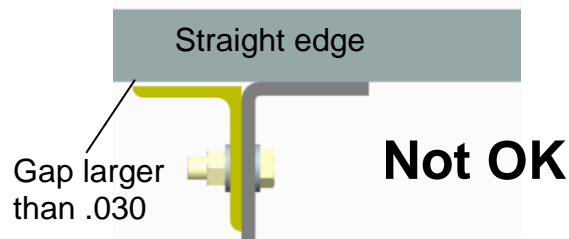
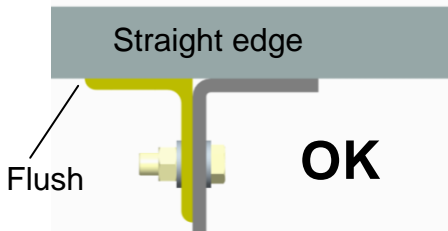

Inspection #1: Mounting Angle Elevation (Outboard Only) Con't

Step 1-6) To correct any of the problems identified in steps 1-1 through 1-5 Loosen all the bolts attaching the mounting angle to the tractor frame and adjust the mounting angle using a straight edge.

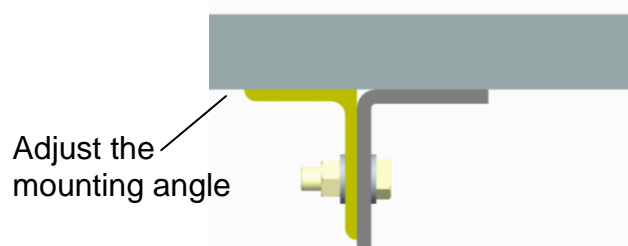
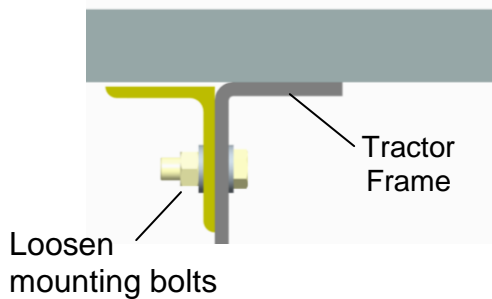

Note: Do not remove the fifth wheel to perform this step.

Note: In most cases the mounting angles will spring back up when loosening.

Step 1-7) After properly aligning the mounting angle tighten all mounting bolts to their proper torque.

Inspection #2: Air Cylinder

Step 2-1) Check for adequate air pressure. The Jost air cylinder requires 90psi to operate.

Step 2-2) Make sure air is off and disconnect the air line from the air cylinder. Energize the air and drain water from the lines. If air *is not* getting to the cylinder check the air system for the failure.

Inspection #2: Air Cylinder Con't

Caution: The mechanism may be under spring tension and could spring closed without warning.

Step 2-3) Remove the bolt attaching the rod end of the cylinder to the pivot arm and swing the cylinder away from the mechanism.

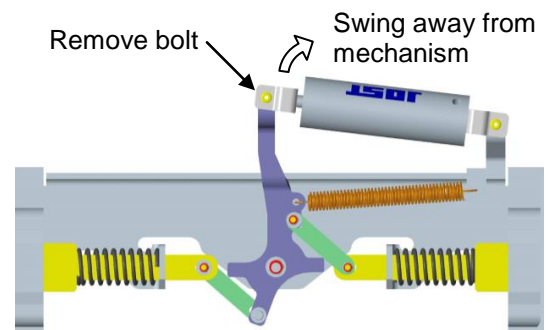

Step 2-4) Verify cylinder extension;
a. Measure the current rod extension.
b. Energize the air to extend the cylinder.
c. Verify that the difference between extended length and retracted length is 5in.

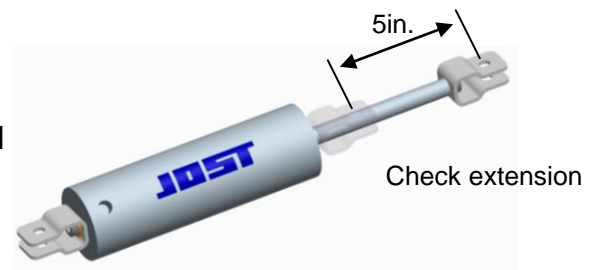

Important:

It may be necessary to drain any water from the air cylinder.

- If rod does not extend or the difference is *less than* 5in, replace the cylinder (see page 5).
- If difference is *equal to* 5in; this indicates that the cylinder is ok but the slider may be out of square or there is a problem with the release mechanism, continue to inspection #3.

Inspection #3: Release Mechanism Operation

Due to infrequent use, the mechanism may be corroded or bound with dirt and debris. It is important to keep this area clean. Follow the steps below to inspect and clean the release mechanism.

Step 3-1) The plungers may be frozen or rusted due to infrequent use. Use a hammer and a large punch to free the plungers by hitting the center tooth, as shown.

- The plungers are loose if you can feel the compression springs re-engaging the plunger.
- If the plunger pushes back and does NOT re-engage clean and lubricate the plunger housing.

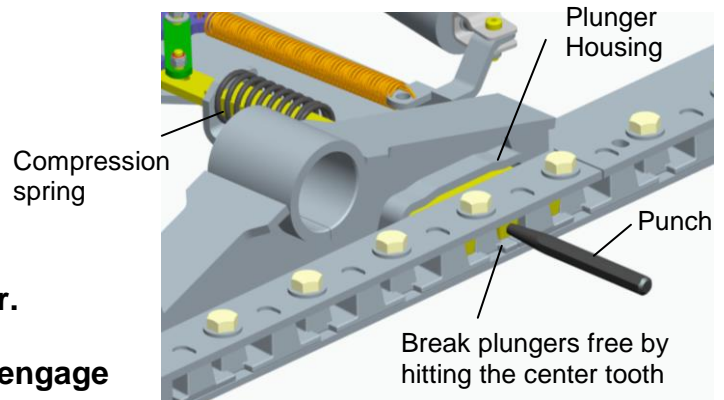

Caution: The mechanism may be under spring tension and could spring closed without warning.

Step 3-2) Remove the bolt attaching the rod end of the cylinder to the pivot arm and swing the cylinder away from the mechanism.

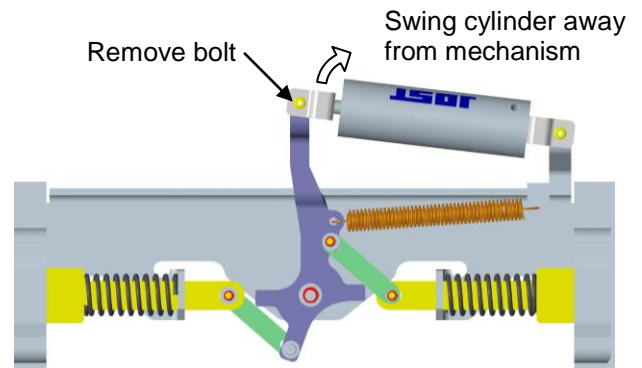

Step 3-3) Place a pipe over the pivot arm and open the release mechanism to break free the corrosion, dirt and debris.

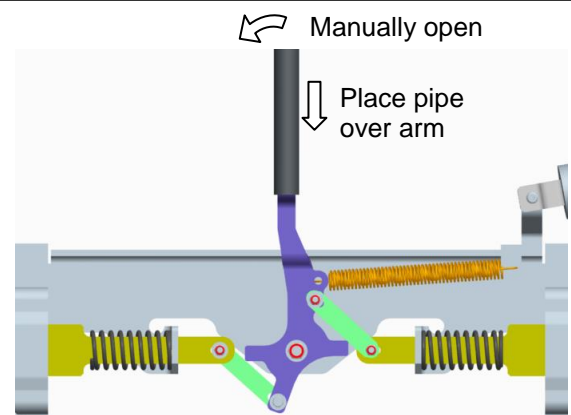

Inspection #3: Release Mechanism Operation Con't

Step 3-4) Clean all pivot points and spray with penetrating oil, like PB Blaster or Kroil.

Step 3-5) Reconnect air cylinder and check for proper operation.

- if the mechanism operates freely go to Inspection #4
- If the mechanism does not operate freely go to step 3-8

Step 3-6) Disassemble mechanism;

- Remove double coil spring.
- Remove lock nut and washer.
- Remove cotter pin and clevis pin from.
- Rotate linkage bars out of the way.

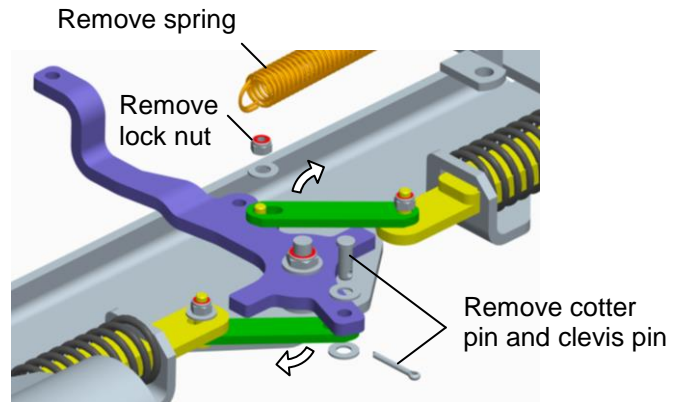

Step 3-7) Remove lock nut and washer from pivot post and remove Pivot Arm and bushing.

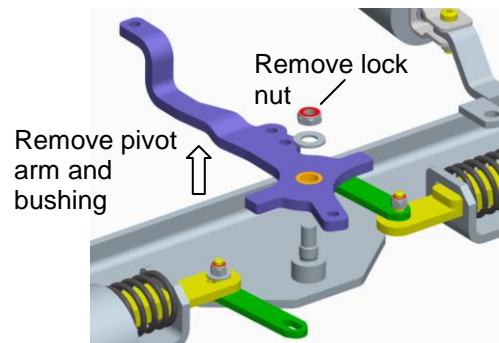

Step 3-8) Remove bushing from pivot arm and replace with new SK-77292-01.

Reassemble with marine grade anti-seize grease on all pivot points.

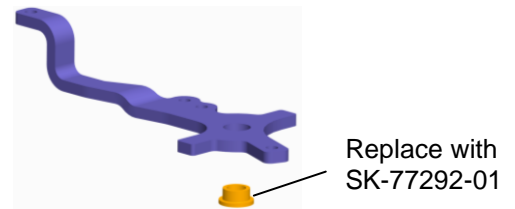

Inspection #4: Slider Squareness

If the slide bed is out of square the locking plungers will not line up with the rack. This will not allow the mechanism to lock properly. You must correct the squareness to ensure proper slider operation. Follow the procedures below.

Step 4-1) Check the slide plate to make sure the front is square to the length of the plate. Use a large square or measure the diagonals.

- If the plate is square go to step 4-4

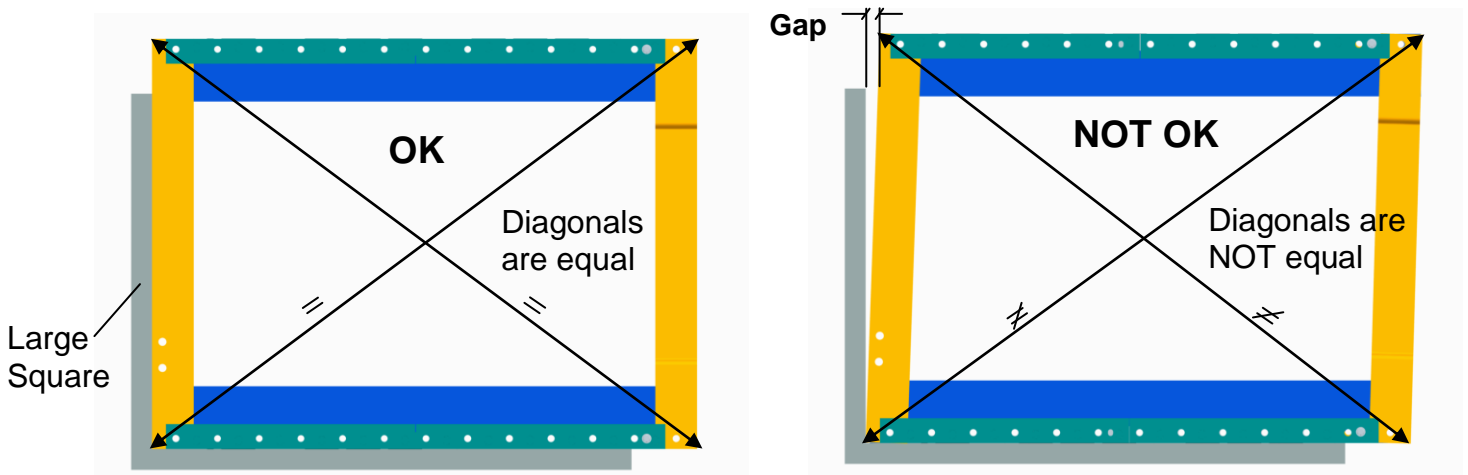

Step 4-2) Loosen the mounting bolts and adjust the slide bed and/or mounting angle using a large square or measure the diagonals.

Note: If proper alignment cannot be reached with the existing bolt hole clearances, correct the problem by measuring and modifying the parts that are not parallel.

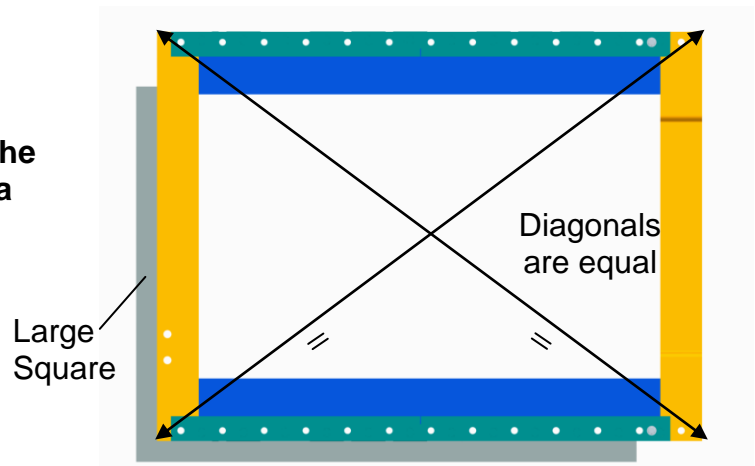

Step 4-3) After properly adjusting, tighten all mounting bolts to their proper torque.

Inspection #4: Slider Squareness Con't

Step 4-4) Inspect that the locking plunger teeth are aligned with the rack on both sides.

- If the teeth are aligned, lock & unlock and check for proper operation.

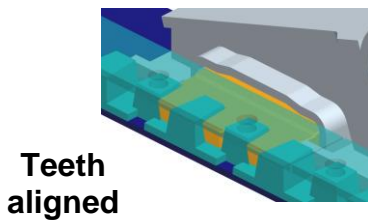

OK

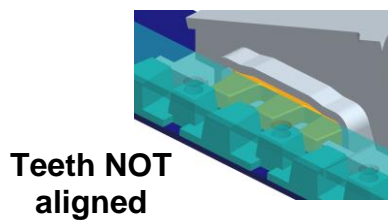

NOT OK

Step 4-5) Slide the bracket to the front or rear stop and check the clearance.

- If there is more clearance on one side, the slide bracket is out of square. Repair or replace as required.

