

**LOCK REPLACEMENT
PROCEDURES**
FOR JSK 37 SERIES FIFTH WHEELS

Cushion and Lock Jaw Rebuild Kit (For L.H. only)
Part #SK 73221-50Z

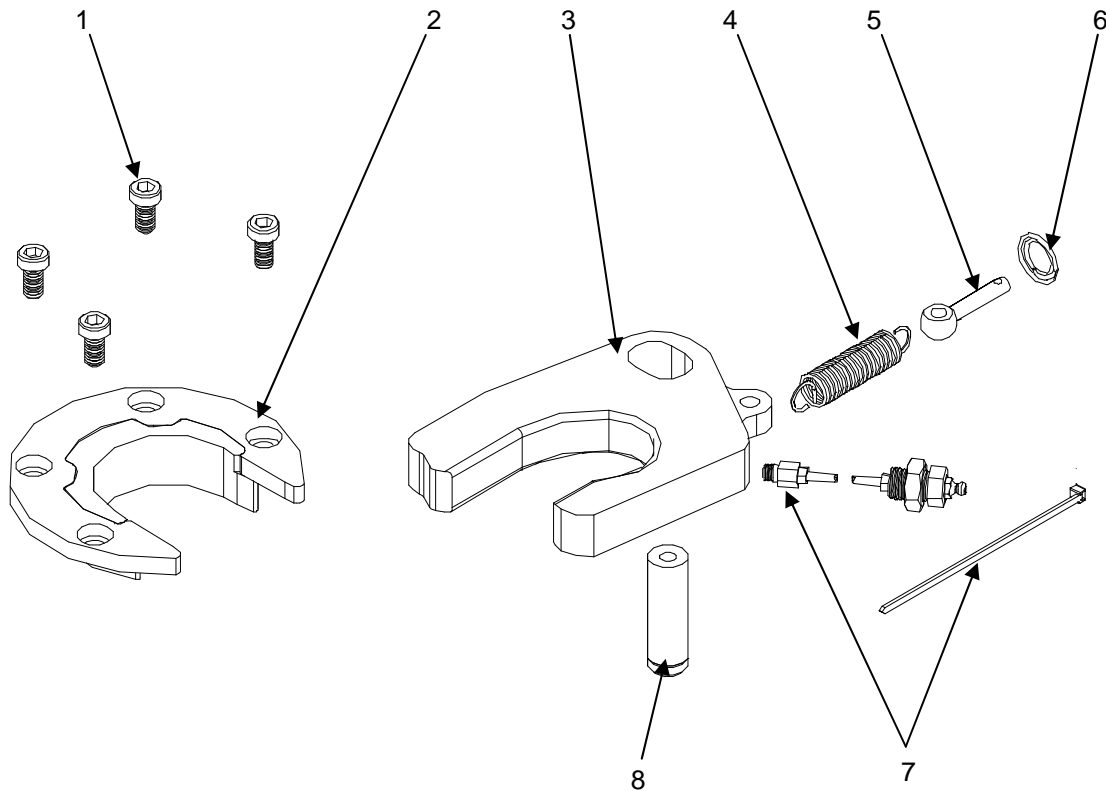

Item	Description	Part No.	Item	Description	Part No.
1	Cushion ring bolt	SK 73121-55	6	Ring	SK 2106-70
2	Cushion Ring Assembly	SK 79002-00	7	Lubricating kit	SK 3108-02
3	Lock jaw	SK 1489LZ	8	Lock jaw pivot pin	SK 72106-67
4	Lock jaw spring	SK 847			
5	Eye bolt	SK 2106-69			

Important: Rebuilding should be considered when all of the available adjustment is used and the lock tester moves fore and aft 1/8" when properly locked.

INSPECTION

1. EXAMINE TOPPLATE SURFACE

If the topplate surface is worn down to the grease groove at any point, the top plate should not be rebuilt it should be discarded. (see figure 1)



FIGURE 1

2. MEASURE TWO PARTS

Measure the cushion ring and the lock jaw, the fifth wheel should be rebuilt if the dimension shown is worn to .69" (17.5mm). (see figures 2 and 3)



FIGURE 2



FIGURE 3

DISASSEMBLY

1. CLOSE THE LOCKING MECHANISM.

Pull the release handle out and swing the lock jaw into the closed position (see figure 4a).



Now let the release handle slide slowly to the closed position (see figure 4b).

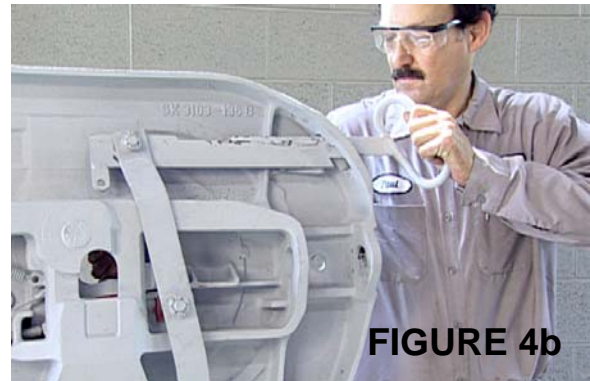

2. REMOVE DOUBLE COIL SPRING.

Using a suitable tool remove the spring from casting lug first (see figure 5).



3. OPEN THE LOCKING MECHANISM.

Slide the release handle to the opened position (see figure 6).



DISASSEMBLY con't

4. REMOVE THE CIRCLE RING.

Remove the circle ring securing the lock jaw spring (see figure 7a) and allow extension spring to relax (see figure 7b).

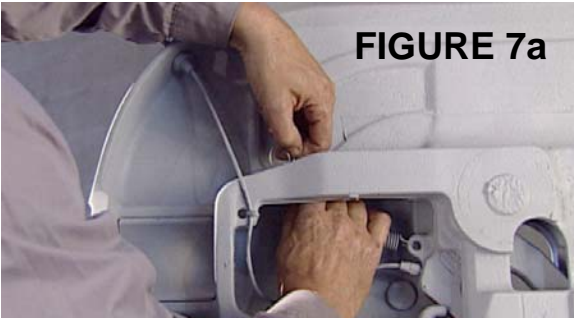

5. REMOVE THE CUSHION RING AND RETAINER.

Remove the (4) cushion ring bolts using a 5/16" Allen wrench (see figure 8a). Then, pry out the cushion ring retainer from the casting and remove the cushion ring (see figure 8b).

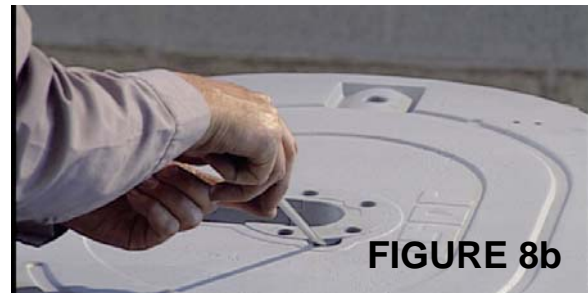

6. REMOVE THE LOCK JAW PIVOT PIN.

Thread one of the cushion ring bolts into the lock jaw pivot pin (see figure 9a) and lift the pin from the casting (see figure 9b).



DISASSEMBLY con't

7. REMOVE THE LOCK JAW.

Remove the lock jaw by reaching under the top plate and sliding the lock out of the casting (see figure 10).

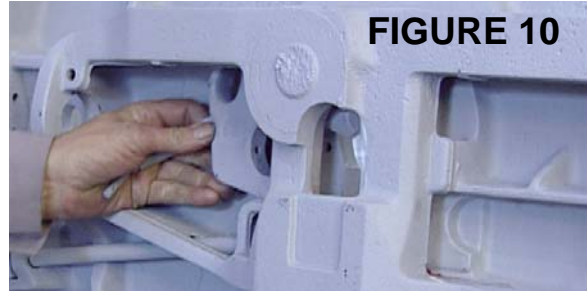

8. REMOVE THE LUBRICATION LINE.

Remove the lubrication line from the lock jaw.

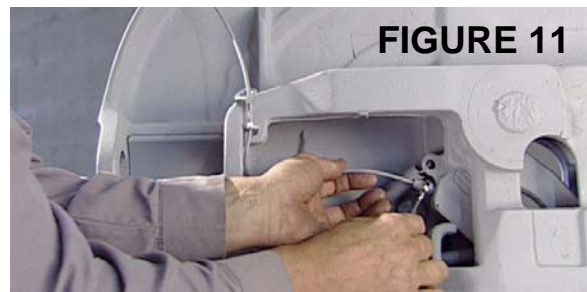

RE-ASSEMBLY

1. INSTALL THE LUBRICATION LINE.

Re-attach the lubrication line to the lock jaw.



2. INSTALL THE LOCK JAW.

Be sure to install the lock jaw in the same orientation it was removed (see figure 13).



3. INSTALL THE CIRCLE RING.

Place the end of the eye bolt through the casting rib and secure with the circle ring (see figure 14).

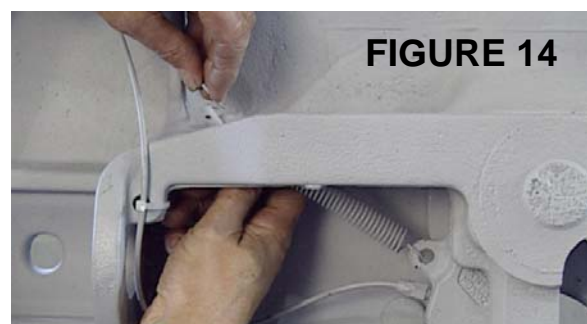

RE-ASSEMBLY con't

4. INSTALL THE LOCK JAW PIVOT PIN.

Lubricate the lock jaw pivot pin and secure the lock jaw by inserting it into the casting through the slot in the lock jaw (see figure 15).

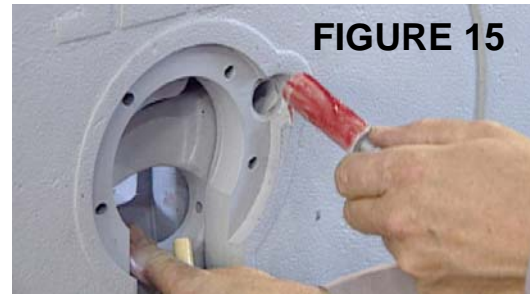

5. INSTALL THE CUSHION RING AND RETAINER.

Carefully line up the bolt holes (see figure 16a), and then install (4) new cushion ring bolts. Tighten and torque bolts to 45 ft-lbs (see figure 16b).

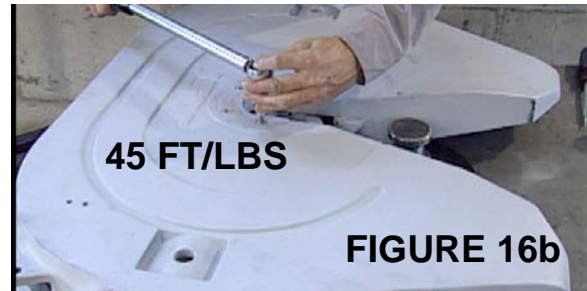
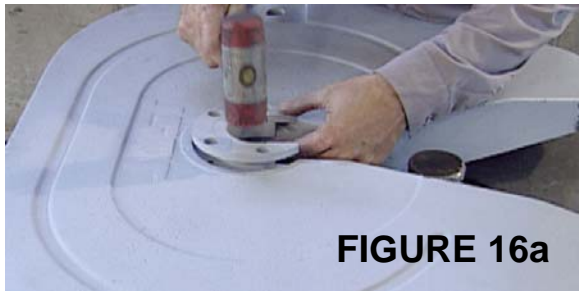

6. CLOSE THE LOCKING MECHANISM.

Pull the release handle out and swing the lock jaw into the closed position (see figure 17a).



Now slide the release handle into the closed position (see figure 17b).



7. ATTACH DOUBLE COIL SPRING.

Using a suitable tool attach the spring as shown (see figure 5).

RE-ASSEMBLY con't

8. CHECK ADJUSTMENT - Lock and unlock several times using a lock tester.

- A. THE LOCK IS PROPERLY ADJUSTED IF: The wheel locks and unlocks easily each time and the lock tester rotates freely.
- B. THE LOCK IS TOO LOOSE IF: You feel fore-aft play when pulling and pushing on the lock tester handle (see figure 18)
- C. THE LOCK IS TOO TIGHT IF: The lock tester does not rotate freely when attempting to rotate it in the lock. (See figure 19)

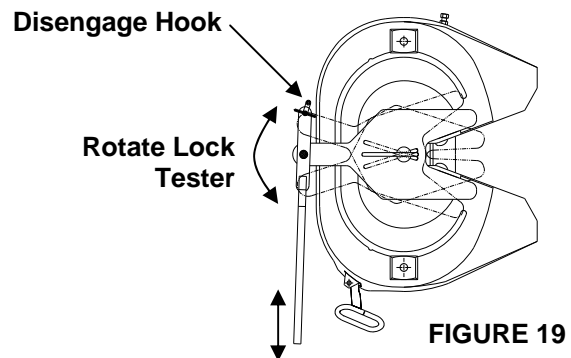
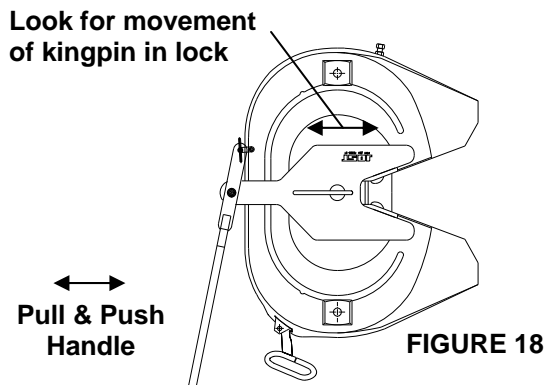

9. CORRECT IMPROPER ADJUSTMENT

- A. IF IT IS TOO TIGHT: loosen the jam nut, turn the adjustment screw clockwise one full turn and reset the jam nut. Then, lock and unlock several times, repeat if necessary.
- B. IF IT IS TOO LOOSE: loosen the jam nut, turn the adjustment screw counterclockwise one full turn and reset the jam nut. Then, lock and unlock several times, repeat if necessary.

