



- 1. FAILURE TO FOLLOW THESE INSTRUCTIONS COULD CAUSE A HAZARDOUS CONDITION!**
- 2. PERFORM ALL MAINTENANCE WITH TRACTOR UNCOUPLED FROM TRAILER.**
- 3. ALL PROCEDURES MUST BE PERFORMED BY QUALIFIED PERSONNEL.**

A. NEW PRODUCT BREAK IN LUBRICATION:

Apply a light coating of a lithium-based grease with EP additive (extreme pressure) to the low lube liner plates. The low lube plates require No further lubrication.

B. LUBRICATION (as required):

- Lubricate the kingpin lock using a hand pump grease gun through the grease zerk provided on the skirt of the fifth wheel (see figure 1). This zerk provides lube directly to the kingpin.
- Apply a light oil to all moving parts.
- For sliding fifth wheels spray diesel fuel on slide path of the base plate.

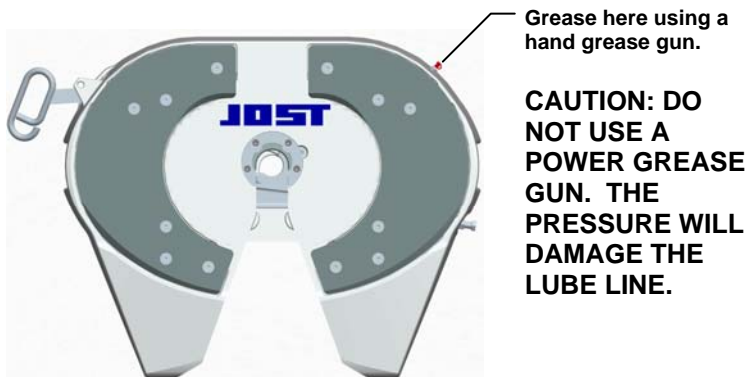

FIGURE 1

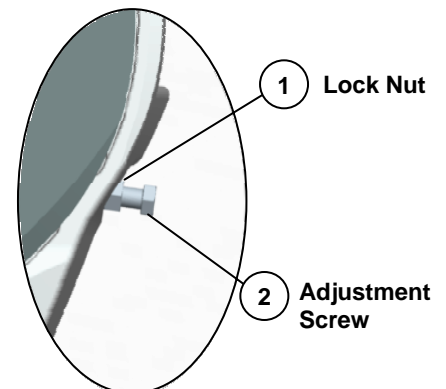
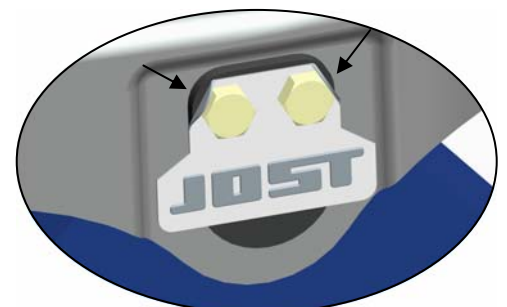

FIGURE 2

C. INSPECTIONS AND ADJUSTMENTS:

(Perform the following every 3 months or 30,000 miles)

- Inspect the mounting – repair or replace any missing or damaged fasteners or broken components.
- Inspect bracket pin bolts, make sure locking tabs are properly securing the bolts in place (see figure #3).
- Inspect the fifth wheel for bent, worn or broken parts. Replace with genuine **JOST** parts.
- Inspect the low lube plates and replace if damaged or when the plate wears down to the securing bolts. It is normal for the outside edges of the plate to pucker slightly. This will not affect their performance.



Locking tabs properly securing bolts

FIGURE 3

5. **Check adjustment** - Lock and unlock several times using a lock tester. Check that the locking mechanism functions properly (see operating instructions).

- A. **The lock is properly adjusted if:** The wheel locks and unlocks easily each time and the lock tester rotates freely.
- B. **The lock is too loose if:** You feel fore-aft play when pulling and pushing on the lock tester handle (see figure 4)
- C. **The lock is too tight if:** The lock tester does not rotate freely when attempting to rotate it in the lock. (See figure 5)

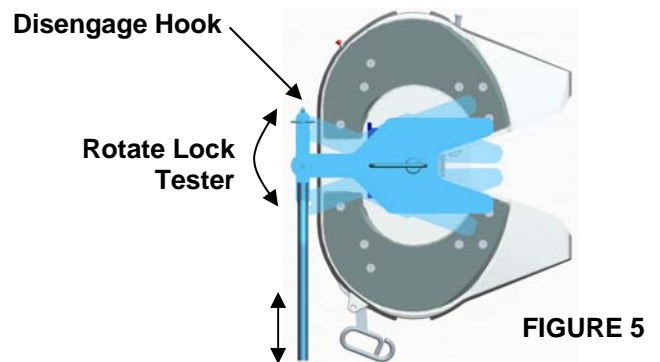
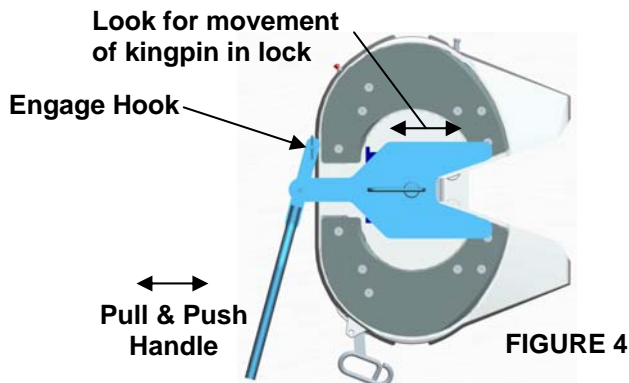

6. **Correct improper adjustment**

- A. **If it is too tight:** loosen the jam nut (see figure 2 item 1), turn the adjustment screw (see figure 2 item 2) clockwise one full turn and reset the jam nut. Then, lock and unlock several times, repeat if necessary.
- B. **If it is too loose:** loosen the jam nut, turn the adjustment screw counterclockwise one full turn and reset the jam nut. Then, lock and unlock several times, repeat if necessary.

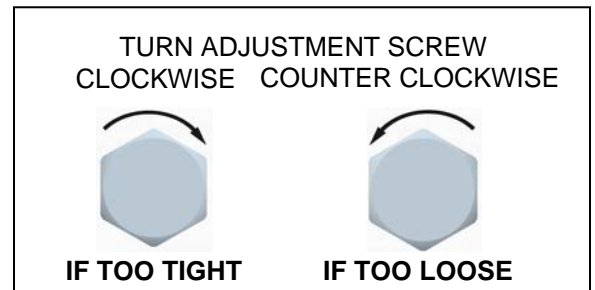



WARNING DO NOT USE ANY FIFTH WHEEL THAT FAILS TO OPERATE PROPERLY!

D. LUBE PLATE REPLACEMENT PROCEDURES (using kit SK3106-003):

1. Remove the securing bolts. If the bolts take a 6mm hex, remove the jam nuts below the topplate first. If the bolts take a T45 torques, just spin off.
2. Remove the plates and clean any debris from the Low Lube pockets of the topplate.
3. Install the new plates.
4. Install the T45 torques securing bolts and tighten to 34 FT-LBS.

SLIDING FIFTH WHEEL MECHANISM INSPECTION AND ADJUSTMENT

A. Inspection

1. Inspect the bracket for any cracks or missing and damaged parts.
2. Inspect the locking plungers for full engagement.
3. Check the locking mechanism for proper operation.
 - a. If plungers won't release – check air cylinder or plunger adjustment.
 - b. If plungers are loose – check plunger adjustment or plunger springs for proper compression. Replace if required.

B. Adjustment

1. The outboard slider assembly requires no adjustment. If the plungers are loose inspect and replace locking mechanism parts as required.
2. The Inboard slider is adjustable for frame width as well as plunger engagement. For adjustment, refer to the Fifth Wheel Installation Instructions (Jost Publication LT SK37U-01).

PARTS LIST

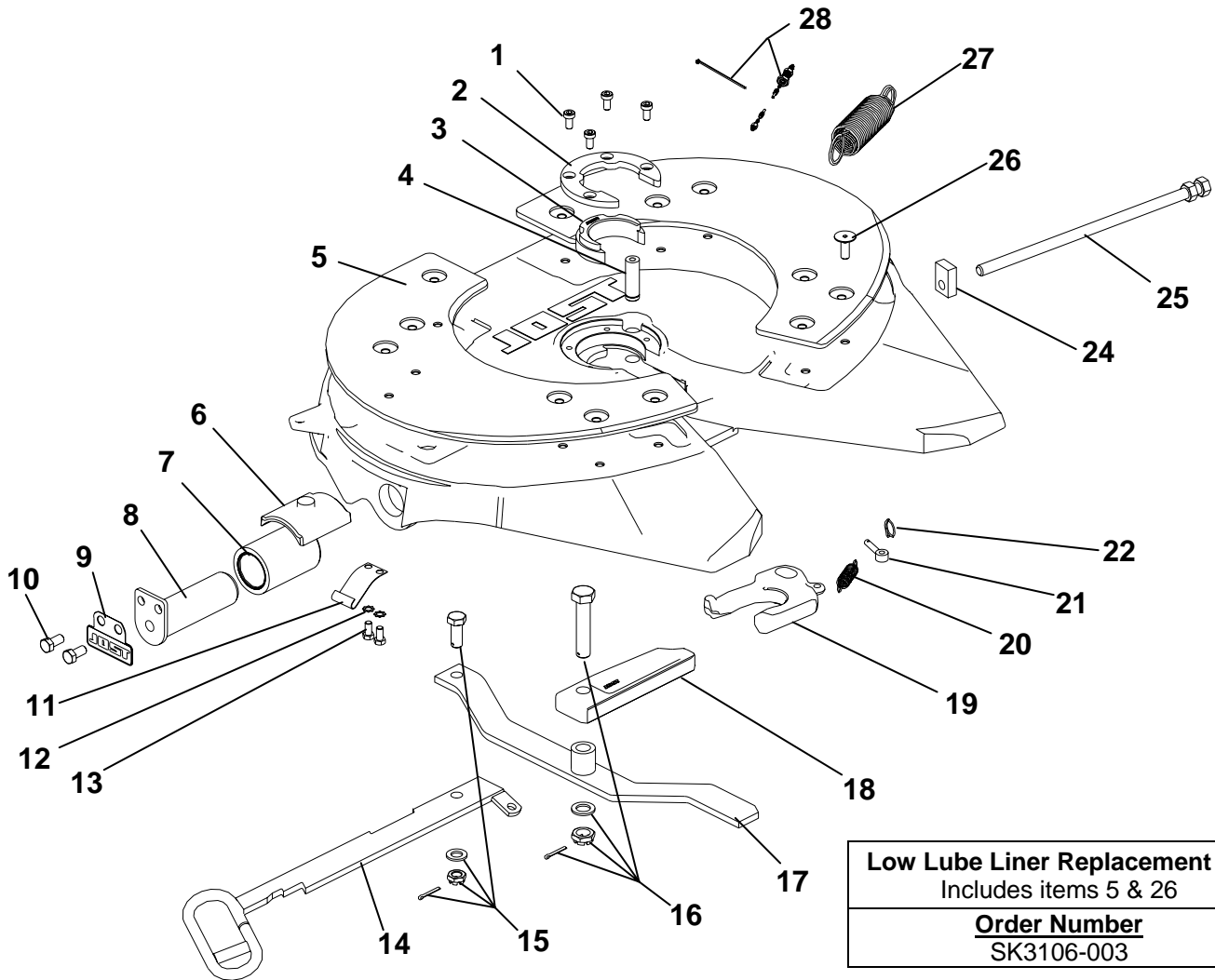

Low Lube Liner Replacement Kit Includes items 5 & 26
Order Number SK3106-003

Item	Description	Part No.	Item	Description	Part No.
1	Cushion ring bolt	SK 73121-55	15	Pivot bolt assembly	SK 71513
2	Retainer	SK 3105-93	16	Locking bar bolt assembly	SK 73221-01
3	Cushion ring insert	SK 3105-92	17	Lever with bushing	SK 3105-140
4	Lock jaw pivot pin	SK 72106-67	18	Locking bar	SK 3205-06
5	Low Lube Liner Plates	SK 3105-129	19	Lock jaw	SK 1489LZ
6	Collar	SK 3105-95	20	Lock jaw spring	SK 847
7	Rubber Bushing	SK 2905-94	21	Eye bolt	SK 2106-69
8	Bracket pin	SK 79011-03	22	Ring	SK 2106-70
9	Tab washer	SK 73104-47	24	Guide piece	SK 73205-07
10	Hex bolt	SK 70202-15	25	Adjusting screw with hex nut	SK 3105-151
11	Plate spring	SK 70993-00	26	Securing bolt	SK0010060
12	External tooth lock washer	SK 70301-00	27	Double tension spring	SK 3105-20
13	Hex bolt	SK 73121-28B	28	Lubricating kit	SK 3108-02
14	Release handle	SK 73105-15			